

Designing with Architectural Insulated Metal Wall Panels

AIA
Continuing
Education
Provider

This Online Learning Seminar is available through a professional courtesy provided by:



Metl-Span

1720 Lakepointe Drive, Suite 101

Lewisville, TX 75057

Tel: 877-585-9969

Fax: 972-420-9382

Email: info@metlespan.com

Web: www.metlespan.com/

©2019 Metl-Span. The material contained in this course was researched, assembled, and produced by Metl-Span and remains its property. "LEED" and related logo is a trademark owned by the U.S. Green Building Council and is used by permission. The LEED® Rating System was authored by and is the property of the USGBC. Any portion of the Rating System appearing in this course is by permission of the USGBC. Questions or concerns about the content of this course should be directed to the program instructor.

Purpose and Learning Objectives

Purpose:

Insulated metal wall panels (IMPs) offer a sleek, modern, and lightweight envelope system that is highly customizable. This course explores the characteristics of IMPs, including how they can offer a six-in-one design solution that provides the exterior and interior finish, as well as the air, vapor, water, and thermal control layers. Discussions also include design options, installation processes, code compliance, sustainability, and available warranties.

Learning Objectives:

At the end of this program, participants will be able to:

- describe the characteristics of architectural insulated metal panels (IMPs), including the design options for architectural IMPs
- discuss the installation process of IMPs, including the factors affecting panel spans, and the relationship of these factors to structural supports
- recognize how IMPs provide all necessary air, water, vapor, and thermal control layers through a single component, and how they meet various building codes, and
- differentiate between the various paint, corrosion, panel, and weather-tightness warranties available with IMPs.

Introduction to Insulated Metal Panels

Insulated metal panels (IMPs) consist of rigid urethane foam sandwiched between two sheets of prepainted metal. IMPs allow for a single component to provide the exterior finish, the interior finish, and all of the building envelope control layers.

IMPs are manufactured in a variety of styles and sizes depending on the application. Steel is the predominant facing material, providing economy with excellent durability. The facings provide aesthetic appeal, act as control layers, protect the foam core from damage, and ensure long-term thermal performance.



IMP Characteristics

Architectural insulated metal panel systems provide a similar level of design options found with rainscreen-type metal wall panel systems, plus some unique performance and installation benefits.

Insulated panels are factory-insulated composites providing insulation values that meet or exceed code requirements for all climate zones.

IMP wall systems minimize trade conflicts, simplify wall system design, and offer all four environmental control layers through the use of a single component. The end result is an attractive, durable wall system that allows for faster building completion in almost any kind of weather without risk to system integrity.

IMPs provide design professionals the opportunity to create functional, attractive, sustainable buildings, and provide owners the opportunity to lower construction, operating, and maintenance costs throughout the life span of the facility.



IMP Market Segments

IMPs are used in a wide variety of segments, including commercial and industrial, cold storage, and architectural. Today's focus is going to be on architectural applications.

- | | |
|-------------------------|---------------|
| Aviation | Retail |
| Correctional Facilities | Self-Storage |
| Distribution Centers | Utility |
| Education | Warehouses |
| Healthcare | Manufacturing |
| Industrial | Multifamily |
| Institutional | Municipal |
| Maintenance | Offices |
| Religious | Recreational |

Architectural

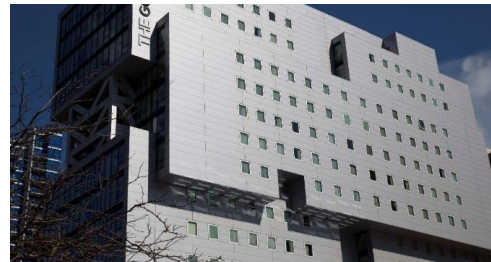

Commercial/Industrial



Cold Storage



Architectural Project Characteristics

Architectural projects are known for their modern aesthetics, more complex details, use of more sophisticated wall assemblies such as rainscreens and insulated metal panels, higher budgets, and use of integrated components. This higher level of sophistication and budgets allows for more design creativity.

Examples of architectural projects include airport/transit terminals, municipal buildings, libraries, corporate offices, city center hotels, convention centers, professional sports facilities, museums, mixed-use residential/commercial and high-end retail.

Design flexibility is similar to aluminum composite panels but with the added benefits of built-in air/water/thermal barriers and lower installed cost (typically).



Architectural Market Description

Thicker-gauge facings provide better flatness and visual appearance than the thinner gauges used for profiled, commercial/industrial panels, and offer longer spans and more impact resistance. Architectural panels are usually flat, but are also available in some profiles such as striated or light mesa (planked). Quite often, they are used for horizontal applications, where panel lengths can be sized to line up with window mullions. Standard widths provide the most cost economy, but custom widths allow the designer the freedom to line up horizontal reveals with window heads and sills, providing a clean, orderly appearance.



Huntsville Aquatic Center, Huntsville, AL, NOLA Van Peurse, CFA

Panel Configurations

Insulated metal panels were first used for cold storage/refrigerated warehouse projects in the 1960s. Advances in manufacturing technology have resulted in significant growth into institutional, commercial/industrial, and high-end architectural markets.

Wider panels offer the best cost efficiencies (both materials and installation labor), but narrow panels are often used to create a more architectural appearance. IMPs are offered in a myriad of profiles and finishes to provide maximum design flexibility. The panels are attached with concealed side joint clips and fasteners (more on this later in the program).

2" to 4" thick (≈R14–30)

Standard widths: 42", 36", 30", 24"

Striated profile



Panel Terminology

In order to effectively communicate design intent to panel manufacturers, it is important to understand some basic terms used for insulated metal panels:

Side joint refers to the edges of the panel that have a tongue and groove interlock. Every panel has two parallel side joints, one on each edge.

End joint refers to the cut ends of the panel. Every panel has two end joints, one on each cut end.

Module (also known as width) refers to the distance from side joint to side joint, and includes panel reveals.

Length refers to the distance from one cut end of the panel to the other.

These terms are applied the same, regardless of panel orientation.

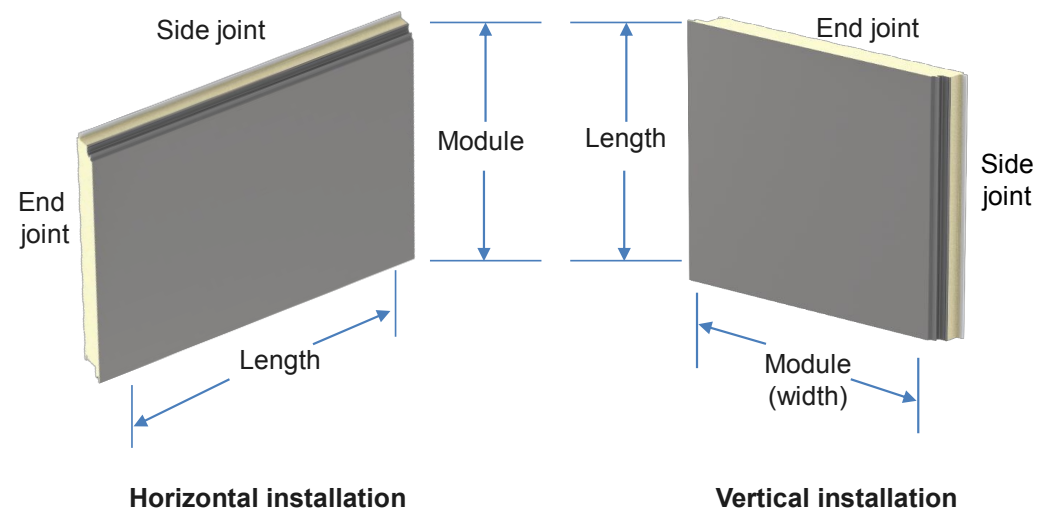

Panel Terminology

There are two common methods of production for insulated metal panels. The first is called *foamed-in-place* (FIP), and involves injecting the foam core between two preformed metal facings, where it cures while the panel assembly is restrained in a mold. This method is the industry standard as it provides excellent adhesion between the metal facings and the insulating core while filling all voids in the panel joinery.

The second process is referred to as *laminated*, and describes the process where the foam core is manufactured prior to adhering the metal facings with an adhesive.



Metrohm, Riverview, FL, HTG Architects, CFA

Design Options: Finishes and Coatings

Now we are going to review various design options available with IMPs.

IMPs are delivered to the construction site pre-painted and ready to install. The typical exterior finish is the industry standard 1.0 mil nominal (including primer) PVDF (polyvinylidene fluoride).

The typical interior finish is a 1.0 mil nominal white polyester, which provides a durable, reflective, and washable surface.

IMP coatings are formulated to provide protection against UV rays, corrosion, humidity, acid rain, and a wide range of chemicals and other pollutants. They are also designed to resist chalking and fade.

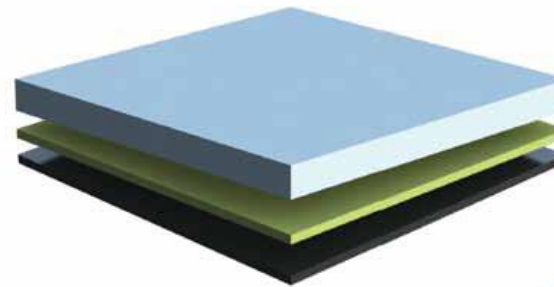

Standard 1.0 mil

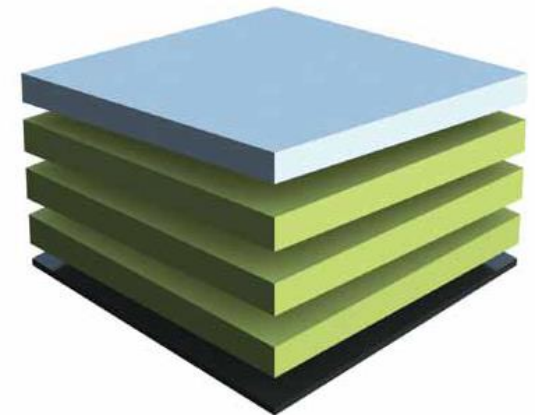

High build 3.2 mil

Design Options: Finishes and Coatings

Specific formulations will protect a building in exceptionally harsh environments, such as those found in seacoast and industrial locations where maximum salt spray and chemical corrosion protection is needed. We'll revisit the implications of harsh environments on paint system and base metal warranty coverage later in the course. Maintenance is limited to periodic wash downs.

Finish options include smooth, embossed, and stucco. Embossed facings are the industry standard, as they provide the most cost-effective combination of appearance and durability. Smooth facings are often desired when using mica and metallic paint finishes.



Smooth finish



Standard embossing



Heavy embossing



Stucco finish

Design Options: Finishes and Coatings

IMPs are offered in a wide variety of colors, textures, and prints.

- Solid colors are available in a nearly universal range.
- Mica and metallic finishes contain flakes that provide sparkle.
- Color-shifting finishes appear to change color when viewed from different angles or in different lighting.
- Weathered metal finishes provide a patina appearance, without having to wait for the natural aging process.
- Printed finishes can provide the appearance of wood or variegated stone.
- Stucco-coated textured panels provide the look of EIFS (exterior insulation and finish system) or textured concrete.

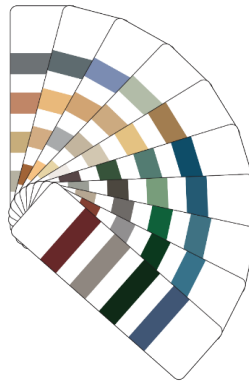

- Solids
- Micas
- Metallics
- Color shifting

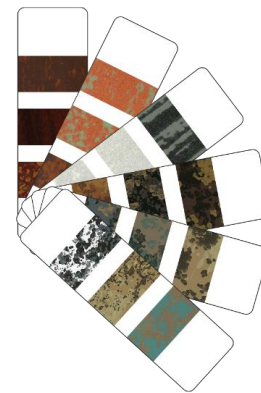

- Weathered metals
- Wood grain
- Patinas
- Variegated stone

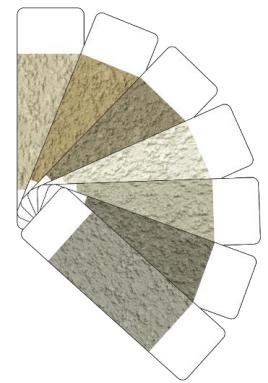

- Stucco
- Precast

Design Options: Finishes and Coatings

This project used a combination of architectural panels with a PVDF finish along with those containing a stucco-like (hard wall) appearance. Because both types of panels have the same joint system, they are easily interchangeable.



Swedish Hospital, Issaquah, WA, Collins Woerman Architects

Design Options: Trimless Ends

Trimless ends (sometimes referred to as endfolds) are a hallmark of architectural horizontally installed insulated metal panels. The exterior panel faces are constructed longer than the finished panel length on one or both ends, then bent back 1" towards the liner side. They are used to finish off panel ends, and hide the exposed foam ends without need for trims or extrusions.

Trimless ends provide a clean, crisp look at the vertical joint areas on flat or low profiled panels. They are not available on panels with pronounced ribs.

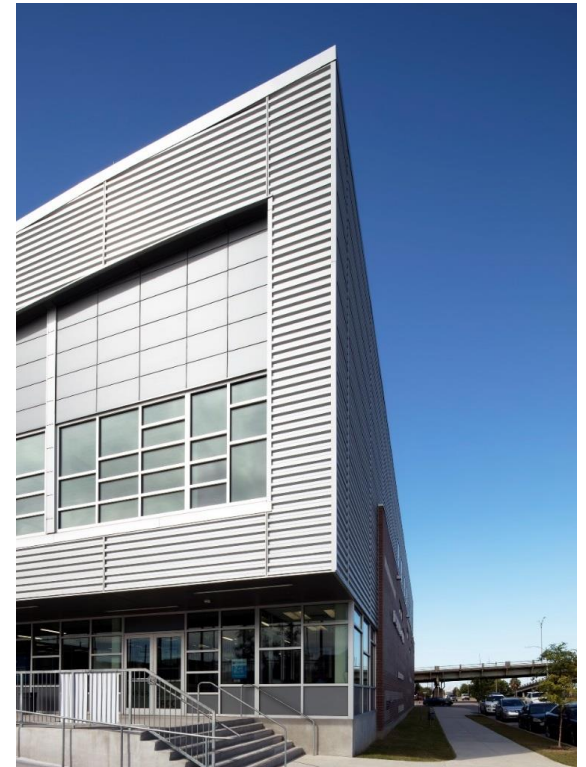
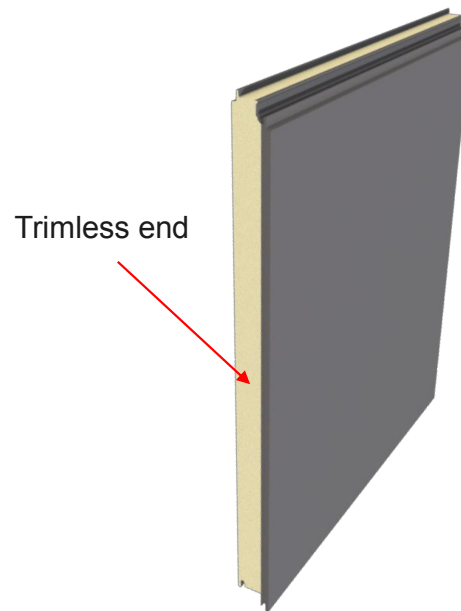

Rosenwald Center Gymnasium, New Orleans, LA

Design Options: Folded Corners

Folded corners are created by V-notching the back side of corner panels, then folding the panels to the desired angle. When the notch runs from side joint to side joint as pictured here, they are sometimes referred to as transverse bent corners. Folded corners are typical for architectural IMP projects.

Folded corners can be factory folded, or field folded. For consistency, manufacturers generally recommend factory-folded corners.

Occasionally, due to budget constraints, painted aluminum extrusions are used in lieu of folded corners. Aluminum extrusions are straighter, flatter (more resistant to oil canning), and more durable compared to flashings formed in a press brake. However, they do require extended lead times when ordering.



Exterior face of panel

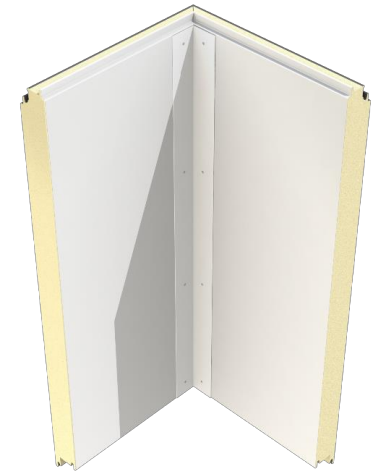

Interior face of panel
after folding

Design Options: Longitudinal Folds

When the backs of the panels are V-notched and folded along the length rather than from edge to edge, they are called longitudinal folds. These types of folds can be used to transition from walls to soffits, or as vertically installed folded corners. When using as vertical corner panels, it is recommended that no more than two folded panels are used on a rectangular building due to installation sequence issues.

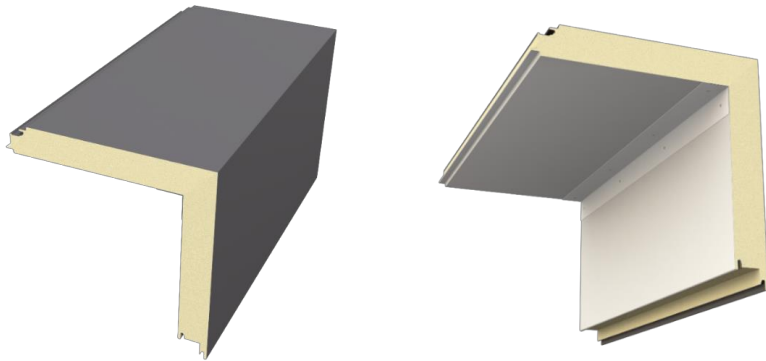

Horizontal (wall-to-soffit condition)



Vertical (folded corner panels)

Design Options: Aluminum Extrusions

Aluminum extrusions are created by pushing aluminum ingots through a die that has been cut out to form a trim shape. Extrusions are most often used in lieu of brake metal trims, but can be used in lieu of trimless ends or folded corners.

- Straighter and flatter than metal flashing (no oil canning)
- Durable—less susceptible to dents from impact or fasteners
- Concealed fasteners
- Painted with spray-applied PVDF (70%)
- More corrosion resistant than metal flashing
- More expensive than metal flashing



Design Options: Reveal Options

Variable reveals are available from closed to 1" in 1/4" increments, and from 1" to 3" in 1/2" increments.

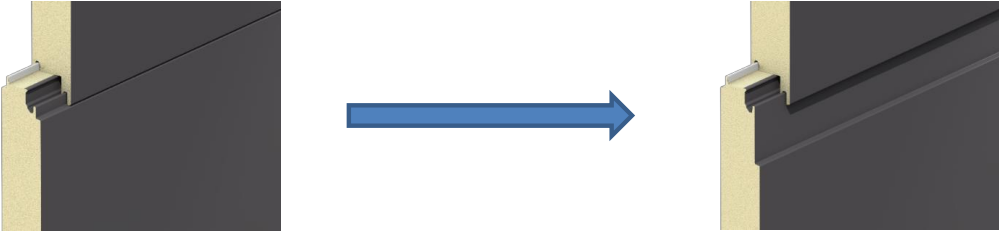

Variable reveals from closed to 3"



Design Options: Variable Reveals with Folded Corners

This example shows how optional larger reveals can be combined with standard reveals and transverse bent (folded) corners to provide visual interest.



Lapel High School, Lapel, IN, Lorenz Williams Clinton

Design Options: Mixed Materials

IMPs can be a perfect complement to traditional building materials such as CMU, wood, and stone. They offer a change in texture, color palette, and geometric patterns.



Confluence Center, Eau Claire, WI, Holzman Moss Bottino Architects

Design Options: Mosaic Patterns

Mosaic patterns are easy to achieve by varying panel widths and colors. Note the use of vertical panels in three different colors along with horizontal panels in charcoal.

This project was a retrofit, starting out as a hotel/casino and ending up as a government office. IMPs are ideal for retrofitting due to their light weight (≈ 3 pounds per square foot), one-step installation, and the fact that new windows are easily integrated into the panel system. We'll revisit retrofits again later in the program.



Detroit Public Safety, Detroit, MI, SmithGroup/JJR

Design Options: IMPs and ACM

This project shows how aluminum composite material (ACM) can be used in conjunction with architectural insulated metal panels. The angled walls are ACM while the vertical wall areas were accomplished with architectural insulated metal panels in a matching color.

Depending on panel and wall geometry, IMPs are often used in lieu of ACM for cost savings, speed of installation, and thermal performance.



NY Film Hub, DeWitt, NY, QPK Design

Design Options: Panels, Windows, and Sunscreen (Fins)

Here we see an example of how integrated, flush windows can be used with IMPs in a mosaic pattern. In addition, the modern appearance of the IMPs is a nice complement to the window fins and glazing system on the adjacent wall.



SORAA, DeWitt, NY, EYP Architecture and Engineering

Design Options: Segmented Curves

Segmented panels are used to create curved walls, and are much less expensive than curved panels. Narrower panels allow a tighter radius while wider panels are more cost-effective for a larger radius.



Ilani Casino, Ridgefield, WA, Friedmutter Group Architect & Design Studios

Design Options: Segmented Curves

This project is unique in that it uses folded horizontal panels to achieve the radius. Instead of ninety-degree transverse folds, it uses a smaller bend in the panels to follow the curvature.

Other areas of the building use a deeper, more pronounced rib profile to create visual interest.



Western Nassau Water Authority, N. New Hyde Park, NY, Angelo Francis Corva & Associates

Design Options: Mixed Profiles

IMPs are offered in a variety of profiles that can be integrated within the same wall elevations. Note the use of flat architectural IMPs mixed with heavily profiled horizontal commercial/industrial IMPs.



Loudon Water Treatment Facility, Leesburg, VA, CDM Smith

Design Options: Variable Grids

Here we see an example of how different sized IMPs along with color variation can be used to provide a variable grid appearance.



SORRA, DeWitt, NY, EYP Architecture and Engineering

Design Options: Horizontal Running Bond Pattern

Here we see an example of how architectural IMPs can be used in a running bond (staggered joint) pattern. This application requires extra attention to detail along with supplemental sealants on the part of the installing contractor. It may also be advisable to use a redundant backup wall when using this offset pattern.

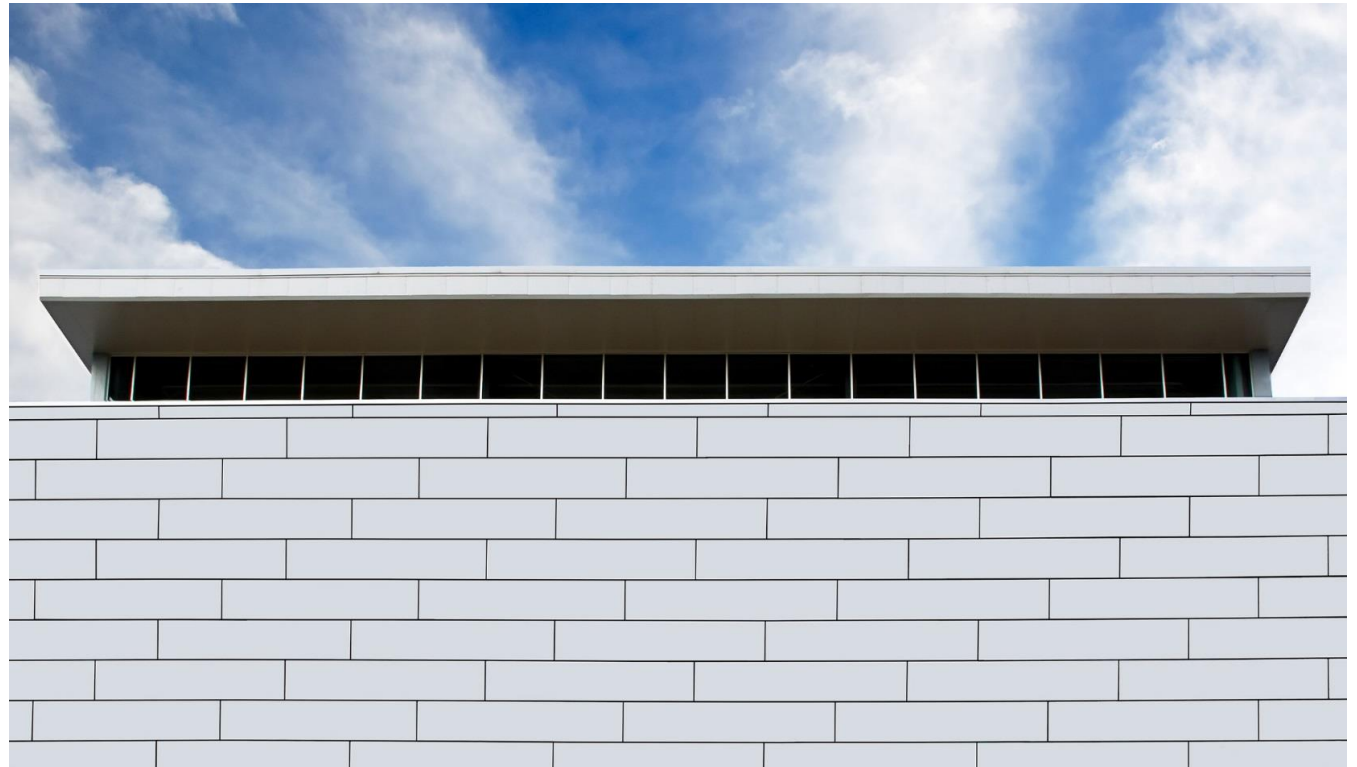

Polyprep Fieldhouse, Brooklyn, NY, Jack L. Gordon Arch PC

Design Options: Mixed Orientation

IMPs can be used in both vertical and horizontal orientations to accommodate changes in wall planes and elevations. Note the use of heavily profiled horizontal commercial/industrial IMPs on the lower course versus the flat, smooth architectural IMPs used above.



Streetscape, Saskatoon, Canada, Streetscape Properties

Design Options: Integrated Windows

Integrated windows provide a simple solution for panel-to-window connections. They also provide continuation of control layers to greatly simplify detailing, installation, and envelope performance.

They are available in several finishes including anodized (clear, bronze, and black), PVDF, and bare aluminum. Features and benefits include minimum sight lines, flush framing, thermally broken extrusions reducing heat loss and improving condensation resistance, and easier installation.

Integrated windows—matches panel joints

- Use with 2" and 3" thick horizontal panels
- Matches panel modules of 24"–36"
- Up to 10' frame height
- Head and sills can be spliced for unlimited widths
- 1" glazing—installed from interior
- 4" deep framework

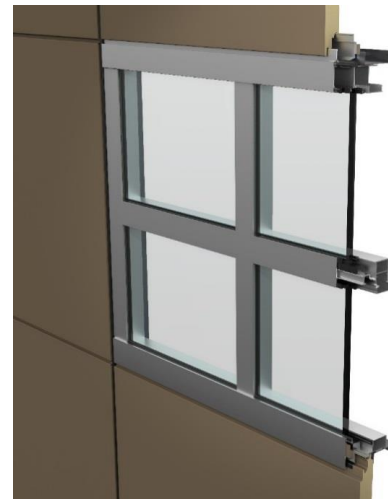

Budgeting with Architectural IMPs

The items on this slide provide some things to consider when balancing aesthetics versus budgets.

- Colors – How many? Quantities meet coil minimums? Standard vs. custom?
- Paint finish – 1.0 mil vs. higher build finishes
- Paint resin type – PVDF vs. FEVE (fluoroethylene vinyl ether)
- Module widths – wide vs. narrow
- Panel lengths – long vs. short
- Single module vs. many modules
- Single profile vs. multiple profiles
- Labor – nonunion vs. prevailing wage (union scale)
- Building height – low-, mid-, or high-rise

Architectural IMPs are affordable for many projects if the details, quantities, panel sizes, colors, and overall complexity are optimized. Installed costs can vary by 100% depending on how complex the panel fabrication is (type, color, modules, lengths) and labor that is involved. It is always good practice to advise your IMP product representative as to budgets early on in the design process to avoid sticker shock at bid time. A good product rep will help you avoid some of the more costly decisions in favor of more economical choices if they are aware of the overall cost constraints.

Support Structure

Panel span conversations often revolve around “the chicken or the egg” theory. Insulated panels by themselves have excellent spanning capabilities. However, panel spans can be limited by the support structure, particularly when it comes to panel attachment. The primary concern is generally negative wind loads, and how to properly fasten the panels to resist these loads.

When attaching to light-gauge supports, fastener pullout is often the limiting factor. When attaching to heavier-gauge supports, panel deflection may be the limiting factor. IMP manufacturers are eager to supply engineering assistance in resolving these issues early on in the design stage. Occasionally, it is advisable to consult with a qualified IMP contractor to determine the most cost-effective solution (example: adding structural supports to decrease panel spans versus thicker or heavier-gauge panels).

In any event, early communication with the panel manufacturer can avoid post-bid surprises and unwanted change orders.

Support Structure

Wall panel spans are determined by wind loads, panel thickness, panel facings (profiles and gauges), structural support gauge and spacing, and deflection criteria.

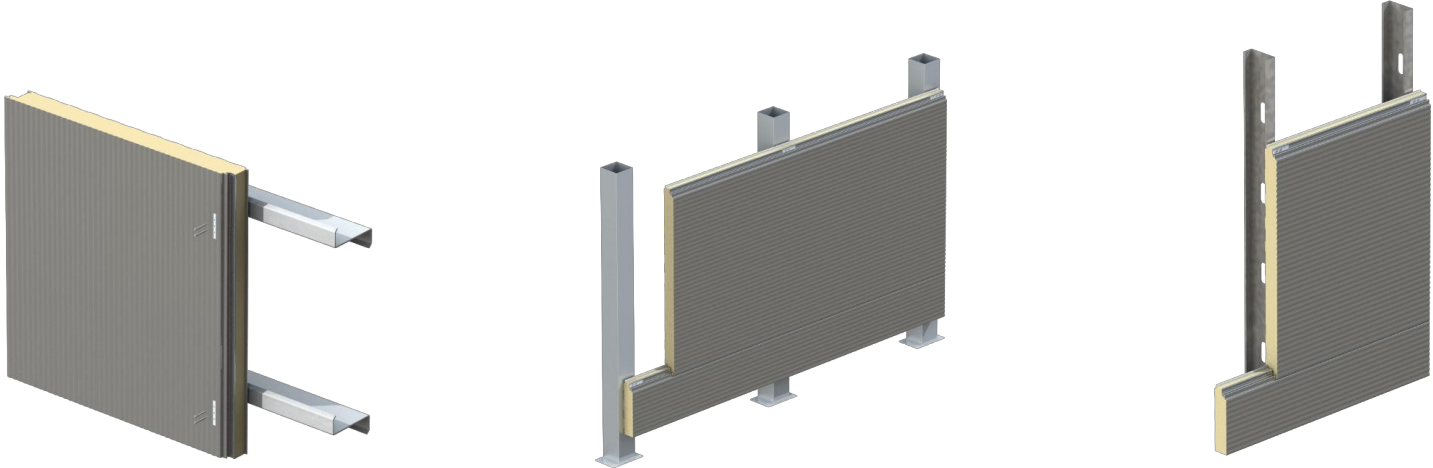

Support Structure: Horizontal IMPs over Vertical Supports

Supporting Steel Alignment

The use of horizontal architectural IMPs generally requires vertical support steel. This can be studs, steel tubes, or - beams. Designers should make sure that the alignment tolerances of the supporting steel are in accordance with the panel manufacturer's recommendations and that the supporting steel is *adjustable*. Failure to adhere to these recommendations may lead to unsatisfactory panel aesthetics.

Stud walls are typically used where there is a need for an interior finish (drywall). Tube steel or I beams are typically used where the panel interiors will be left exposed.

Tolerances:

- Vertical supports should be adjustable inwards/outwards of wall plane
- Alignment critical to panel appearance
- Slight outward bow = acceptable
- Inward bow = not acceptable

Support Structure: Horizontal IMPs over Vertical Supports

Architectural panels require a flat support wall for the best possible appearance.

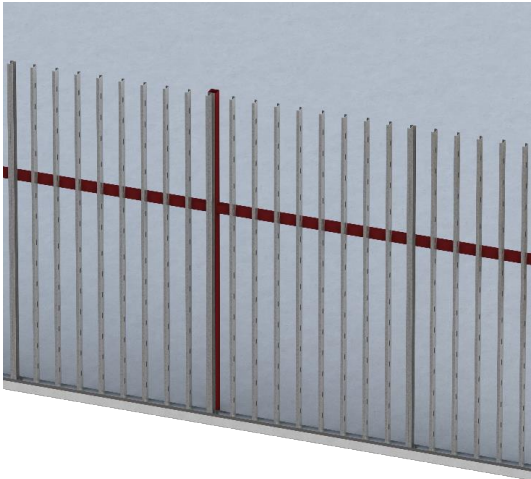

Stud wall

*< 4' spacing: + 1/16", - 0"
4' < 8' spacing: + 1/8", - 0"
≥ 8' spacing: + 1/4", - 0"*

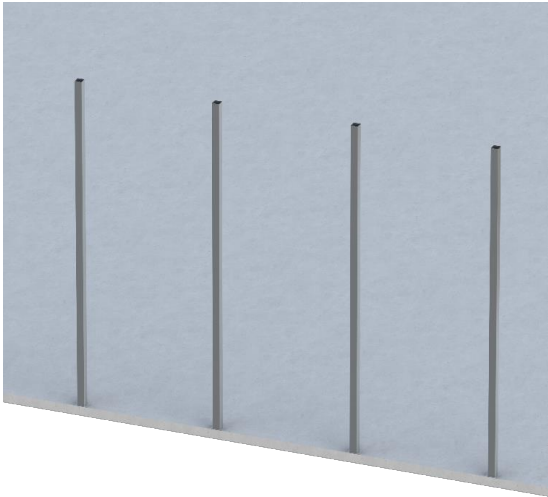

Tube steel

Support Structure: Vertical IMPs over Horizontal Supports

Supporting Steel Alignment

The use of vertical architectural IMPs generally requires horizontal support steel. This can be cold-formed Cs or Zs, open web joists, hot rolled channel, or I beams (wideflange). Designers should make sure that the alignment tolerances of the supporting steel are in accordance with the panel manufacturer's recommendations and that the supporting steel is adjustable. Failure to adhere to these recommendations may lead to unsatisfactory panel aesthetics.

Tolerances:

- Horizontal supports should be adjustable inwards/outwards of wall plane
- Girt alignment critical to panel appearance
- Slight outward bow = acceptable
- Inward bow = not acceptable

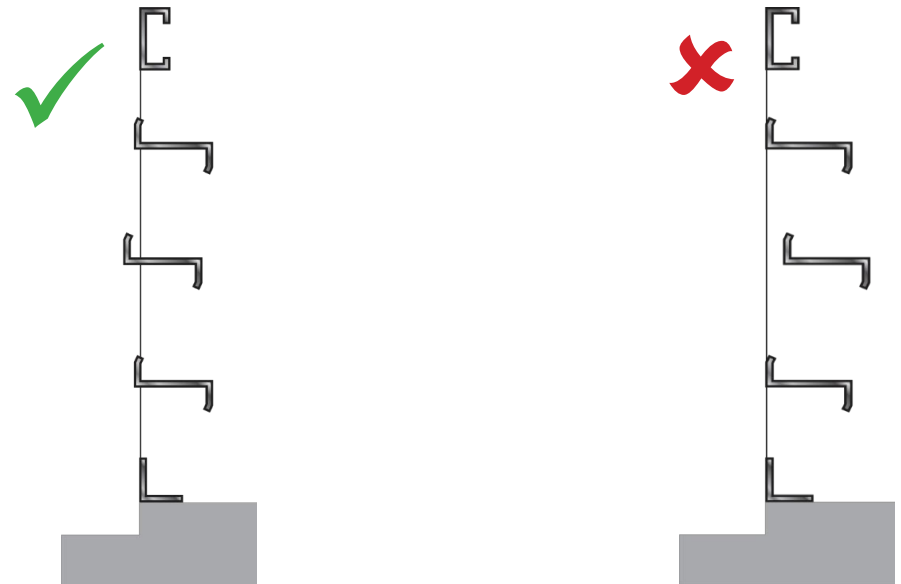

< 4' spacing: + 1/16", - 0"
4' < 8' spacing: + 1/8", - 0"
≥ 8' spacing: + 1/4", - 0"

Installation

Panel Erection Efficiency

- The one-step construction process ensures rapid completion of the wall system.
- Factory-fabricated IMPs are attached directly to the supporting structure and eliminate the multiple steps needed to install a traditional multicomponent wall system.
- Erection efficiency with insulated metal panels is higher than with other field-assembled products, because they are lightweight and less affected by weather conditions.
- Faster building completion means reduced construction and interim financing costs.
- Erection speed is the key to many projects today.
- Depending on job complexity and size, IMPs can be installed at a rate of up to 5,000 sq ft per 8-hour shift by a four-man crew on a project using 42" wide vertical panels, and up to 1,100 sq ft per 8-hour shift by a four-man crew using 24"–36" horizontal architectural panels.
- On large building projects with normal wind conditions, support girt spacing in the 5' to 12' range is used to take advantage of the high panel strength.



Metrohm, Riverview, FL,
HTG Architects

Installation Process: Horizontal Panels

The most important step in the installation process is to check the steel for proper alignment before hanging the panels!

- The first step involves attaching mending plates (trim pieces) with pop rivets at every double stud location. This is where the vertical joints occur when using horizontal panels.
- A chalk line is used to establish the proper starting point for attaching the base support extrusion.
- Butyl sealant is then applied to the vertical leg of the stud track. This will seal the stud track to the back of the base support extrusion. Note the sealant gaps at the mending plate locations.
- Urethane sealant is then applied at the slab edge to seal between the concrete and the base extrusion. Note the sealant gaps at the mending plate locations.
- The base extrusion is now set in place and attached with flat head fasteners. Note the gaps in the extrusion at the vertical mending plates. These gaps allow any water that enters into the vertical joint area to freely drain out at the base of the wall.
- The first panel receives butyl sealant in both female panel joints, providing a double barrier wall system.
- Vertical lines of butyl sealant are added to the mending plate. This provides a weather seal from the back of the panel to the mending plate.

Installation Process: Horizontal Panels

- The panel is then set onto the base support, aligned, and secured in place with clips and fasteners through the top male legs of the panel. (The amount of fasteners and clip spacing may vary from job to job depending on engineering requirements.)
- The next panel along the bottom row is prepared in the same way, with butyl sealant added to both female joints. It is placed on the base extrusion and aligned to provide the proper vertical reveal, and secured in place.
- “Marriage beads” of butyl sealant are applied to connect the mending plate sealant with the panel joint at the top edge of the panel. This provides continuity of the air/vapor and water control layers.
- The same process is repeated along the perimeter of the building. It is also possible to complete installation of the panels one elevation at a time. In either case, the bottom row of panels is critical to set vertical joint locations, which are often designed to align with windows and doors.
- Corner panels may be added first as control points, after completion of each elevation, or after all elevations are completed. It is up to the discretion of the installing contractor to determine when the corner panels are installed.
- In the animation (shown on upcoming slide), the vertical columns of panels are installed from the bottom up, working along each elevation until completed.
- For integrated window systems, the windows are installed prior to the panels on each side of the opening as shown in the video.

Installation Process: Horizontal Panels

- The corner panels are now ready to be installed. Butyl sealant is added to both female panel joints and to the mending plates at those locations. The panel is then set in place and attached with clips and fasteners.
- Marriage beads of butyl sealant are applied to connect the mending plate sealant with panel joints at the top edge of the panel.
- The process is then repeated at all corner locations.
- The final step includes completing the vertical joint assembly. First a small quantity of mineral wool filler is inserted, providing insulation and a stop for the EPDM (ethylene-propylene diene monomer) gasket that follows. Next urethane sealant is applied along the edges of the trimless ends in order to hold the EPDM gasket in place, followed by the EPDM gasket.

Installation: Horizontal Panels

This video shows what is involved in the installation of horizontal IMPs.



[Click on the image to view the video on YouTube \(no audio\).](#)

Installation Tips

- Choosing the right installer is critical for proper architectural IMP aesthetics. In particular, horizontal panel application requires a significant attention to detail. Installing contractors should have a minimum of five years' experience on similar projects of similar size and complexity. They should also have completed the panel manufacturer's installation training.
- Larger and/or complex jobs should also require a mock-up wall including windows. Mock-up walls are the best way to verify that the design intent, details, and installation practices yield proper aesthetics and performance.
- Wall framing tolerances should be equal to or tighter than those required for the insulated metal panels. The aesthetics of architectural panels are only as good as the quality of installation of the supporting wall system.
- Folded (continuous) corner panels require that both wall elevations are straight and true, as the panel transitions from one wall elevation to the adjacent wall.
- It is generally best to specify factory-folded corners and trimless ends for consistent quality. Some installers are capable of post-fabricating these options, but quality can vary significantly from installer to installer.
- Labor costs for horizontal architectural panels are higher than for vertical architectural panels or commercial/industrial panels. This is due to the fact that horizontal architectural IMPs are shorter and narrower, require more exact alignment of vertical joints, and typically involve the use of folded corners, trimless ends, and more sophisticated window systems and accessories.

Review Questions

The use of horizontal architectural IMPs generally requires vertical support steel. This can include

- A. studs.
- B. steel beams.
- C. tubes.
- D. All of the above

What are the advantages of trimless ends (sometimes referred to as endfolds) on IMPs?

Answers

The use of horizontal architectural IMPs generally requires vertical support steel. This can include

A. studs.

B. steel beams.

C. tubes.

D. All of the above *Failure to adhere to these recommendations may lead to unsatisfactory panel aesthetics.*

What are the advantages of trimless ends (sometimes referred to as endfolds) on IMPs?

Trimless ends provide a clean, crisp look at the vertical joint areas on flat or low profiled panels.

IMPs and Building Control Layers

Hygrothermal is a term building scientists use to describe the loads that heat, air, and moisture exert on a building. In the following slides, we will describe how IMPs provide all necessary control layers without the need for additional materials.

This video will further explain how IMPs help buildings resist hygrothermal forces.

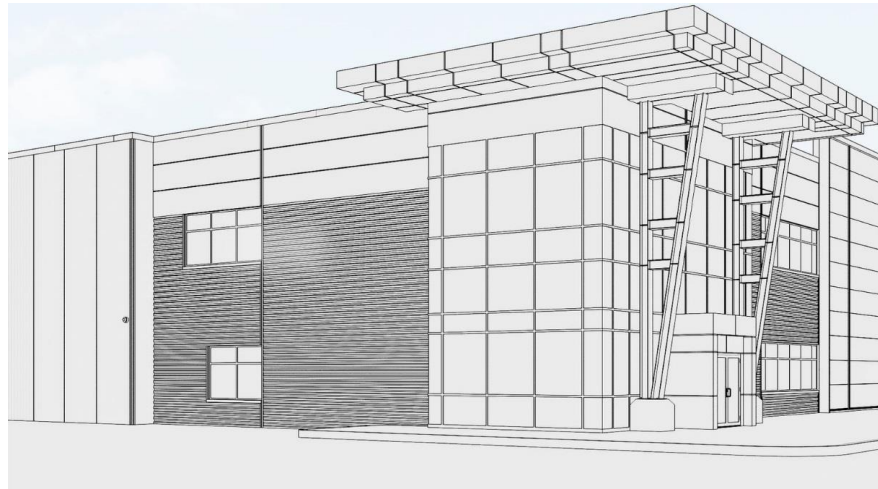

[Click on the image to view the video on YouTube \(includes audio\).](#)

IMPs and Building Control Layers: Water

Barrier walls are characterized by a single layer that must repel all rainwater. There is no redundancy in these systems.

Rainscreen systems have a water-shedding exterior layer, an air gap, and a redundant drainage plane.

Insulated metal panels are a unique hybrid of barrier walls and rainscreen systems. IMPs combine the installation simplicity and economies of a barrier wall with the performance aspects of rainscreens.



Barrier walls — single line of defense:

- Lacks redundancy

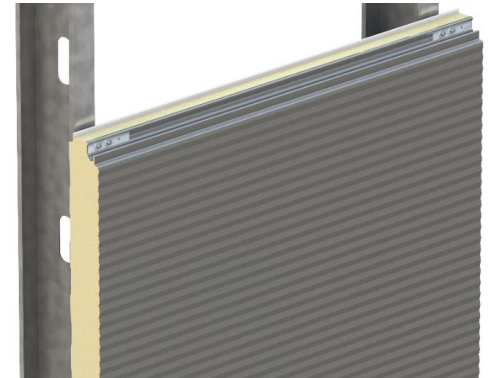

Insulated metal panels — hybrid technology, barrier and rainscreen functionality:

- Outer water-shedding layer
- Integral joint drainage
- Interior liner side provides redundancy

IMPs and Building Control Layers: Thermal

IMPs are one of the simplest ways to meet or exceed energy code requirements, and ensure owners have an efficient state-of-the-art building envelope. From an earlier slide, we learned that IMPs were first used as an optimum solution to one of the most demanding building environments—cold storage facilities. IMPs have been used from the North Pole (housing and offices for North Slope oil workers) all the way to the South Pole (McMurdo Station in Antarctica) and everywhere in between.

Increasing the R-value of the building is as simple as using a thicker panel.

Insulated metal panels minimize thermal bridging.

- Panels faces are separated
- Foam-to-foam edge contact ($\geq 2.5''$ thick panels) provides continuous insulation
- Panel mounting clips attach to exterior facings only
- Architectural panel R-values up to ≈ 32 (4")

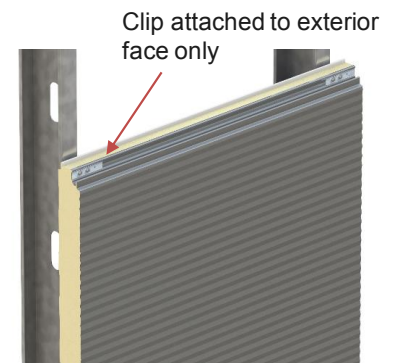
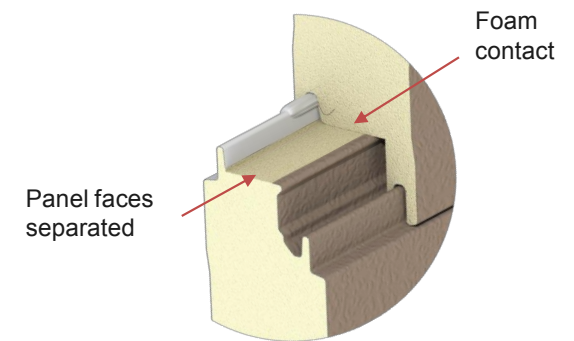

IMPs and Building Control Layers: Air

IMPs provide extremely effective air barriers, and do not require redundant wall control layers, making them a simple solution to one of today's design challenges. We'll review this a bit more when we get to the code compliance portion of the course.

IMPs:

- Protect against air infiltration
- Serve double duty as vapor barrier
- Do not require redundant assemblies



Insulated metal panel



Wraps



Fluid applied

IMPs and Building Control Layers: Vapor

IMPs provide an extremely effective vapor barrier (the inner metal skin of the panels coupled with proper sealants). Because the panels are nonhygroscopic (do not absorb moisture from the air), they form an ideal moisture barrier.

Vapor barriers effectively stop the passage of vapor.

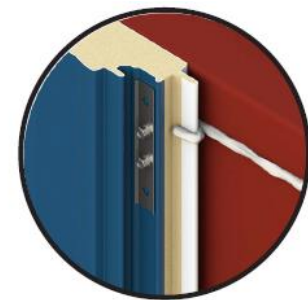
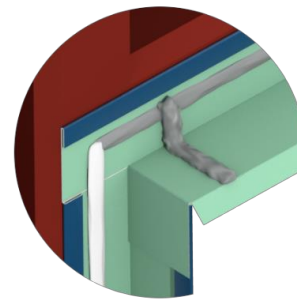

IMPs and Building Control Layers: Barrier Walls

Because of their excellent performance and durability as stand-alone cladding systems, IMPs also make excellent barrier walls for various rainscreen assemblies. This approach provides the same advantages as insulated metal panels, including simplified detailing, quicker installation, and reduced trades. This in turn reduces risk for the architect.

The minimum $\frac{3}{8}$ " tolerances for air gaps noted on this slide are based on typical construction tolerances. Historically, 1" gaps are typically specified but are not technically required for proper performance. In the case of brick veneer, 1"+ is normally used due to mortar spillage between the veneer and the barrier wall.



IMPs over metal cladding: Minimum continuous $\frac{3}{8}$ " air gap



Brick veneer: 1" air gap



Terra-cotta tile: Minimum continuous $\frac{3}{8}$ " air gap

Code Compliance: Fire

To conform to the requirements of the International Building Code, insulated metal panels are evaluated by Underwriters Laboratories, Factory Mutual, and other agencies. Large-scale testing such as FM 4880 qualifies under the “Special Approval” section of Chapter 26 Plastics. This means that IMPs with FM 4880 Approval Listings satisfy all thermal barrier requirements listed in Chapter 26, Section 2603.4, so no separate thermal barrier is required.

To meet FM 4880 and FM 4881 Approval Standards, the foam core must have a maximum flame spread of 25 and a maximum smoke developed rating of 450.

Multistory construction containing combustible wall assembly components such as IMPs, ACM (aluminum composite material), composites, and rigid board must comply with NFPA 285. The installed condition must be in accordance with the tested configuration.

Summary

- **FM 4880/4881:** Large-scale testing regimen for wall systems
 - Flame Spread of ≤ 25 , Smoke Developed rating ≤ 450 (Class A)
 - Applies to single-story buildings of unlimited height
- **NFPA 285:** Fire propagation test for multi-story assemblies

Code Compliance: Structural

Structural load capacity should be verified by representative structural tests for positive as well as negative wind loads as outlined in ASTM E72 for walls and roofs.

The maximum deflection criterion for insulated metal panel walls is typically L/180.

The IMP manufacturer should provide calculations verifying that all factors affecting the load-carrying capacity of the panels have been analyzed and verified by testing and that the structural capacity of the panels meets the project requirements. Negative wind load is typically the limiting factor when determining panel spans.

Summary

- **ASTM E72:** Structural test for positive/negative wind loads
 - Deflection criteria used exceeds code requirements
 - L/180 for walls and L/240 for roofs

Code Compliance: Thermal Transmittance

Architectural IMPs provide R-values generally ranging from 14 to 32+ as tested per ASTM C518, “Standard Test Method for Steady-State Thermal Transmission Properties by means of the Heat Flow Meter Apparatus,” at 75°F mean temperature. This test measures the performance of the insulating core only and is used to determine material R-values.

ASTM C1363 Standard Test Method for Thermal Performance of Building Materials and Envelope Assemblies by Means of a Hot Box Apparatus tests the performance of the panel assembly (including facings and panel joints), and is used to determine assembly U values.

Thermal values should be specified based on local codes, usage, and occupancy.

Technical services can provide data for all three energy code compliance pathways:

- Prescriptive tables
- Envelope trade-off
- Building energy cost budget

Code Compliance: Air and Water Penetration

Air Infiltration

A complete panel assembly containing at least one principal panel side joint should be tested in accordance with ASTM E 283 Standard Test Method for Determining Rate of Air Leakage Through Exterior Windows, Curtain Walls, and Doors Under Specified Pressure Differences Across the Specimen. Air infiltration should not exceed 0.04 cfm/sf at 1.57 psf air pressure differential for wall panel assemblies.

Water Penetration

A complete panel assembly mounted vertically containing panel side joints should be tested in accordance with ASTM E 331 Standard Test Method for Water Penetration of Exterior Windows, Skylights, Doors, and Curtain Walls by Uniform Static Air Pressure Difference with no uncontrolled water leakage at 6.24 psf air pressure differential for two hours.

Code Compliance and Aesthetics: Ideal for Retrofits

IMPs are code compliant and make an excellent choice for retrofitting existing structures. On average, only 3% is added each year to our inventory of buildings, the remaining 97% are existing. Many of these facilities are still structurally sound and in desirable locations, but are sorely outdated in terms of building performance and aesthetics.

As discussed earlier, IMPs are an ideal solution for retrofits due to their modern aesthetics, light weight (approximately 3 pounds per square foot), and superb environmental control layers.

Review Questions

Why do IMPs provide an extremely effective vapor barrier (the inner metal skin of the panels coupled with proper sealants)?

Why are IMPs an ideal solution for retrofit applications?

Answers

Why do IMPs provide an extremely effective vapor barrier (the inner metal skin of the panels coupled with proper sealants)?

Because the panels are nonhygroscopic (do not absorb moisture from the air), they form an ideal moisture barrier.

Why are IMPs an ideal solution for retrofit applications?

IMPs are an ideal solution for retrofits due to their modern aesthetics, light weight (approximately 3 pounds per square foot), and superb environmental control layers.

Case Studies

Let's take a look at some additional before and after pictures of a recently remodeled commercial building using architectural insulated metal panels

Before



After



54 Middlesex Turnpike, Bedford, MA, Dacon Corporation & PDA Associates

Case Studies

Before



After



54 Middlesex Turnpike, Bedford, MA, Dacon Corporation & PDA Associates

IMP Product Installation Warranties

Chalk is gradual breakdown of the paint resin, resulting in a chalk-like powdery appearance

Fade is measured in delta units, where each unit represents the minimum difference visible to the naked eye.

Adhesion is measured by the use of a scratch test. The panel sample is scratched with a cross hatch pattern, and then tape is used to try and lift off the damage.

Paint finish warranties:

- Chalk, fade and adhesion
- Terms for each may not be the same

Paint system resin determines extent of warranties:

- PVDF (polyvinylidene fluoride)
- FEVE (fluoroethylene vinyl ether)

Thicker paint films help protect against substrate failure, but is not a guarantee. Note that paint warranties apply to the paint film itself and not the underlying metal. They are not the same as corrosion warranties.

IMP Product Installation Warranties

An easy way to remember desired results for paint durability is *chalk high, fade low*.

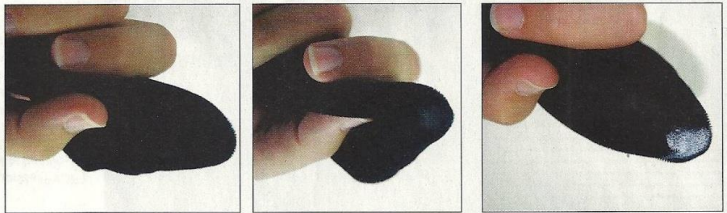
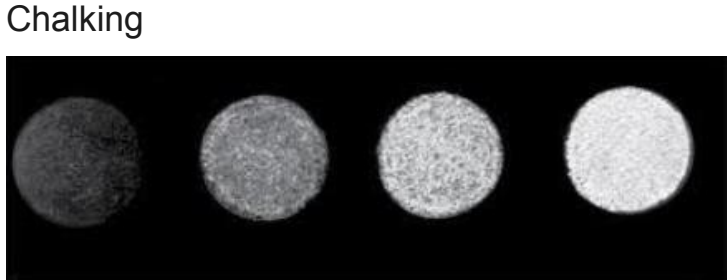

Minimum chalking
#8 rating

Lots of chalking
#2 rating

IMP Product Installation Warranties

Corrosion warranties

- Apply to base metal only
- Require the use of AZ-50 coated steel
- Are not available with G-90 substrates
- Exclusions
 - projects within 1,500 feet of marine environment
 - corrosive environments (chemical processing, waste water plants etc.)

Although the temptation is strong, do not specify corrosion warranties for projects in corrosive environments. The reality is that the warranties offered by coil suppliers all contain exclusions when the product is used in corrosive environments. Your best bet is to consult the IMP manufacturer for the best available substrate and paint system, but be aware that corrosion warranties may not apply for certain applications.

Corrosion warranties are different than paint warranties and apply to the underlying metal substrate, not the paint.

IMP Product Installation Warranties

Weather-tightness warranties

- Most leaks are installation related
- Some leaks are detail/design related
- Very few leaks are product related
- Some IMP manufacturers offer weather-tightness warranties, but typically require installing contractor participation
- Best bet = weather-tightness warranty should be provided by General Contractor

The key to a successful IMP installation is to use an installer who has been trained and certified by the manufacturer. The better certification programs mandate both individual and company participation.

Manufacturers supply materials and recommended installation details. It is important to remember that the panel supplier does not hire the installing contractor, the General Contractor does.

Sustainability and Transparency

Reducing Carbon Footprint

IMPs provide outstanding thermal performance, offering some of the highest R-values per inch of today's insulation materials.

IMPs help reduce a building's carbon footprint by reducing energy consumption. IMPs are considered green building products that can contribute to meeting the requirements of many rating, certification, and labeling programs.

IMPs can contribute to many LEED® credits, including: Integrated Design Process, Rainwater Management (roofs), Heat Island Reduction (roofs), Construction and Demolition Waste Management, Life Cycle Assessments, and Environmental Product Declarations.

Type III Environmental Product Declarations (EPDs) offer users an in-depth look at the environmental impacts of building materials. From raw material extraction to end of service life, these reports are helpful in making balanced and informed product decisions.

For more information on the LEED program, please contact www.usgbc.org.



Sustainability and Transparency

A Health Product Declaration® is a fairly new type of product assessment that deals with the materials used to manufacture construction products. These chemicals and compounds are then cross-referenced against various “chemical red lists” to identify possible health risks and exposure limitations.

For more information about HPDs, their principles, and programs, please visit the Health Product Declaration Collaborative at www.hpd-collaborative.org.

Environmental Product Declarations are available from all major IMP manufacturers.

Contact your chosen IMP manufacturer for more details on LEED credits, LCAs, EPDs and HPDs.

Sustainability and Transparency

IMPs contain a significant amount of recycled content in both the metal facings and the insulating core. At end of life, metal skins can be stripped from the panels and recycled. The foam core can be safely landfilled, or ground and used as paving additives.

The important thing to remember is that the environmental cost of foam is offset by the building's increased thermal efficiency. Using petroleum to create insulation is a "higher use" of the material than burning as fuel.

IMPs

- Average recycled content of facings \approx 25–35% (mainly post-consumer)
- Average recycled content of foam core \approx 15% (mainly pre-consumer)
- Long life cycle \approx 60 years
- Steel 100% recyclable at end of use
- Environmental cost of foam offset by increased thermal efficiency
- Core can be safely disposed of, or ground and used as additives for paving

Summary

- Sleek, modern, and lightweight envelope system that is highly customizable.
- Single-component, six-in-one IMP design provides exterior and interior finish, air, vapor, water, and thermal control layers in a single component.
- IMPs simplify wall system installation, reducing conflicts between trades.
- IMPs offer significant labor and time savings vs. multicomponent assemblies.
- Single source responsibility for warranties, including weather-tightness.
- Provides the ultimate envelope protection whether used as a stand-alone cladding or barrier wall behind rainscreen cladding.
- Meets or exceeds all current code requirements for fire safety, insulation, and air barriers.
- Environmentally sustainable, backed by EPDs and HPDs.